

cemp[®]

Flameproof
Motors

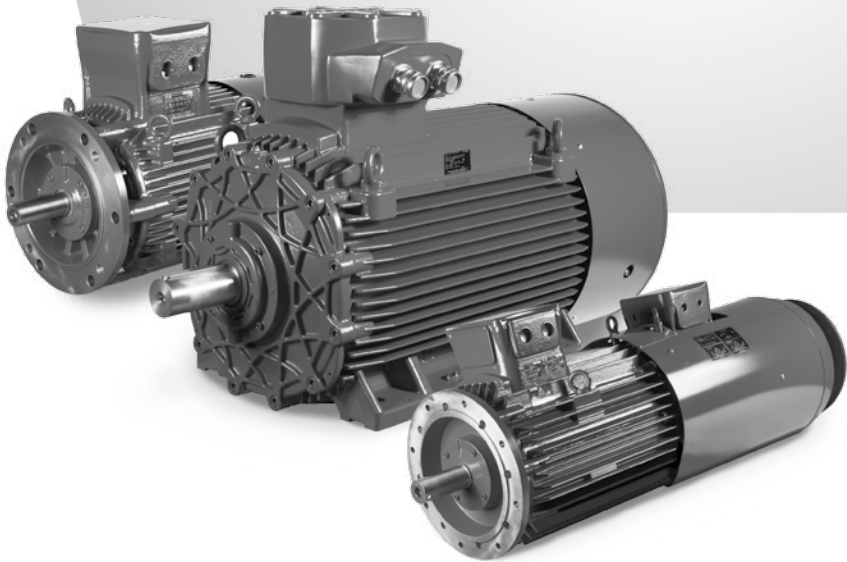

Electric Motors

ATEX safety instructions

A Regal Brand

REGAL[®]

CONTENTS

	Page
1. Introduction	18
2. Identification of flameproof motors	18
2.1 Suitability of the motor to the location of installation.....	18
2.2 Nameplate safety data	19
3. Installation	21
3.1 Mains	21
3.2 Auxiliary connections.....	22
3.3 Cable entries.....	22
3.4 Earthing connection.....	23
3.5 Further warnings for the installation.....	23
3.6 Warning regarding electrostatic charges	24
3.7 Special operating conditions.....	24
4. Motors without terminals with cable leading out of plate	24
4.1 Motor with plate, armoured cable and cable gland	24
4.2 Motor with plate and conduit	24
5. Motors without fan	26
5.1 Cooling method IC 418	26
5.2 Cooling method IC 410	26
6. Motors with forced ventilation	26
6.1 Cooling method IC 416	26
7. Motors for low temperatures	27
8. Motors suitable for frequency converter drive	27
9. Motors with brake	28
9.1 General remarks	28
9.2 Brake power supply.....	28
10. Inspection and maintenance of motors ..	28
11. Repair of classified areas motors	29

1. Introduction

These safety instructions refer to the installation, operation and maintenance of flameproof motors for use in areas where there is a presence of potentially explosive atmospheres.

This document treats various safety aspects that involve motors with different constructive variants. The pertinent sections are brought in the following table:

Flameproof motor	Paragraph
Group I motors	1-2-3-10
Motors for Gas or Dust	1-2-3-10
Motors without terminal box	1-2-3-4-10
Motors without fan	1-2-3-5-10
Motors with forced ventilation	1-2-3-6-10
Motors for low temperatures	1-2-3-7-10
Motors energised by inverter	1-2-3-8-10
Brake motors	1-2-3-9-10

Motors treat in this instruction are:

- Motors Group I
- Motors Group II for Gas
- Motors for dust

Group I Motors for MINE

The flameproof motors for mine have the following protection types against the risk of explosion:

- Ex db I: motor and terminal box flameproof enclosures with degree of protection IP65
- Ex db eb I : flameproof enclosure for motor and increased safety for terminal box with degree of protection IP65.

Group II motors for GAS

The flameproof motors have the following protection types against the risk of explosion:

- Ex db IIB/IIC: motor and terminal box with flameproof enclosures
- Ex db eb IIB/IIC: motor with flameproof enclosure and increased safety for terminal box

Motors for DUST

Motors for environments where combustible dusts are present, have motor and terminal box with protection type Ex tb, tight enclosure with mechanical protection IP6x.

These “Safety Instructions” must be followed in addition to those provided in the “Instructions and maintenance” manual.

2. Identification of flameproof motors

2.1 Suitability of the motor to the location of installation

The user shall check that motor is suitable to the area classification and to the characteristics of the flammable substances present.

National Law, local Rules and Standards establish the essential safety requirements against the risk of explosion in classified areas.

2.1.1 Underground installation - Mine

Classification criterions of the installations in mine are regulated by Laws and National Standards and also from local rules. Motor choice and installation must be effected in accord to such prescriptions.

2.1.2 Places subject to the presence of inflammable gas, fumes or mists

The classification criteria for areas subject to the risk of explosion are laid down in the EN 60079-10-1 standard.

The technical requirements for electrical plants located in classified areas are established by the EN 60079-14 standard.

The choice of the type of motor, according to these technical and legislative provisions, must take into account the following factors:

- type of plant: above ground plants
- zone classification: 0, 1, 2
- characteristics of the flammable substances present in the form of gases, vapours or mists:
 - sub-group: IIA, IIB, IIC
 - temperature class T1, T2, T3, T4, T5, T6 (defines the ignition temperature of the gases).

2.1.3 Places subject to the presence of combustible dust



The classification criteria for areas subject to the risk of explosion are laid down in the EN 60079-10-2 standard. The criteria for choosing and installing equipment in classified areas subject to dust are given in the EN 60079-14 standard. On the basis of these technical and legislative requirements, the type of motor must be chosen, taking the following factors into account:



- surface plants
- zones: 20, 21, 22
- Characteristics of inflammable substances in the form of clouds or layers of dust:
 - Level of mechanical protection required (IP6x or IP5x).
 - Maximum surface temperature allowed.
 - Dust group IIIC or IIIB.



2.2 Nameplate safety data

In addition to operating data, the information provided on the nameplate, includes:

- information necessary to identify the appropriate type of motor and for the correct installation of the motor itself.
- references to the notified bodies responsible for certification.

MARKING MOTORS FOR MINES	
	Mark of conformity to the applicable European directives
	Community mark specifically indicating explosion protection
I M2	Motor suitable for mines group
Ex db (Ex db eb)	Flameproof motor with flameproof terminal box (Flameproof motor with increased safety terminal box)
I	Enclosure appropriate for underground installation: Group I for mines
150°C	Motor temperature class (maximum surface temperature)
Mb	Equipment protection level
*** yy ATEX zzzz	***: laboratory that issued the ATEX certificate type yy: year in which the certificate was issued zzzz: ATEX certificate number
0000	Reference number of the notified body that executed the notification of the production system quality

MARKING MOTORS FOR GAS	
	Mark of conformity to the applicable European directives
	Community mark specifically indicating explosion protection
II 2G	Motor suitable for above ground plants with the presence of category 2G gases or vapours
Ex db (Ex db eb)	Flameproof motor with flameproof terminal box (Flameproof motor with increased safety terminal box)
IIC (IIB)	Enclosure appropriate for substances in group IIC (or group IIB)
T3 (T4) (T5) (T6)	Motor temperature class (maximum surface temperature)
Gb	Equipment protection level
*** yy ATEX zzzz	***: laboratory that issued the ATEX certificate type yy: year in which the certificate was issued zzzz: ATEX certificate number
0000	Reference number of the notified body that executed the notification of the production system quality

MARKING MOTORS FOR DUST	
	Mark of conformity to the applicable European directives
	Community mark specifically indicating explosion protection
II 2D	Motor suitable for above ground plants with the presence of category 2G gases or vapours
Ex tb	Motor with protective enclosure against dust penetration
IIIC (IIB)	Enclosure appropriate for substances in group IIIC (or group IIB)
T150 °C (T135 °C) (T100 °C) (T85 °C)	Maximum motor surface temperature
IP 6x	Mechanical protection level of motor and terminal box
Db	Equipment protection level
*** yy ATEX zzzz	***: laboratory that issued the ATEX certificate type yy: year in which the certificate was issued zzzz: ATEX certificate number
0000	Reference number of the notified body that executed the notification of the production system quality

Notes:

- IIC (IIIC) motors are also suitable for environments with substances classified as IIA (IIIA) and IIB (IIIB).
- IIB (IIIB) motors are suitable for environments with IIA (IIIA) classified substances.
- Motors with a given temperature class are also suitable for all substances with a higher temperature class (for example: T4 motors are suitable for substances with a T3, T2, T1 temperature class).
- If the certificate number indicated on the nameplate is followed by an "X", the user must follow specific conditions of use described in this manual.
- Flameproof motors are normally made to be used at an ambient temperature in the range of $-20\text{ °C} \div +40\text{ °C}$. If the motor has to be employed for operations outside these ambient temperature range, the temperature values must be specified at the time the order is issued and indicated on the nameplate.
- The class of the screws is written on the plate. In case of replacing, screws of the same type must be used (ex: class 8.8 or class A4-80).
- The motor has been designed to operate at the speeds indicated on the identification plate. The information provided in our catalogues must be observed to prevent the motor from overheating.
- The motors are available in various construction solutions based on the type of operation shown on the nameplate. In particular, for motors with brake make sure that:
 - unventilated motors for intermittent operations (S2 or S4) work following the cycles shown on the nameplate and are not used in continuous operations;
 - motors for lifting have the indication S3 or S4 on their nameplates and are actually intended for the operation shown in the plate;
 - the moment of inertia of the driven load does not exceed the one shown on the nameplate.

3. Installation

3.1 Mains

Connections to the mains must be performed as shown in the wiring diagrams supplied with the motor.

Connection to the power terminal is made, depending on the type of motor, in the sequence indicated in the figures below (Fig. 1, Fig. 2, Fig. 3).

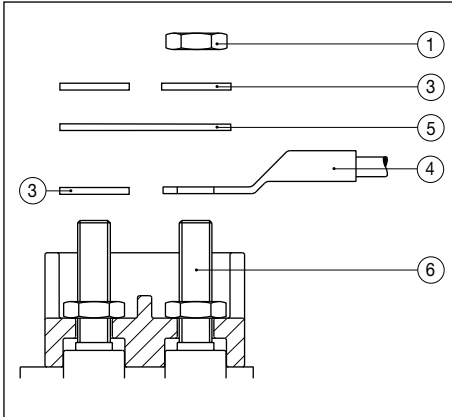

Figure 1 - Connection sequence 56÷80
(Aluminium frame)

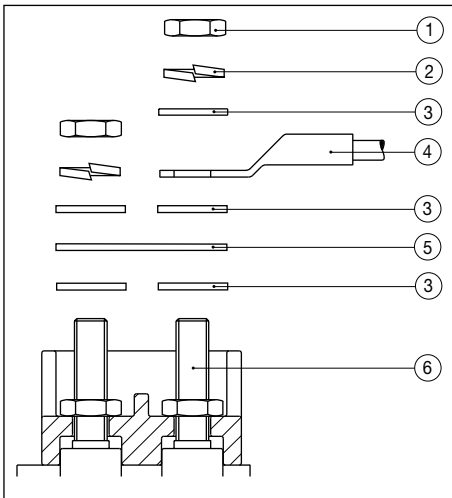

Figure 2 - Connection sequence 63÷250
(Cast iron frame)

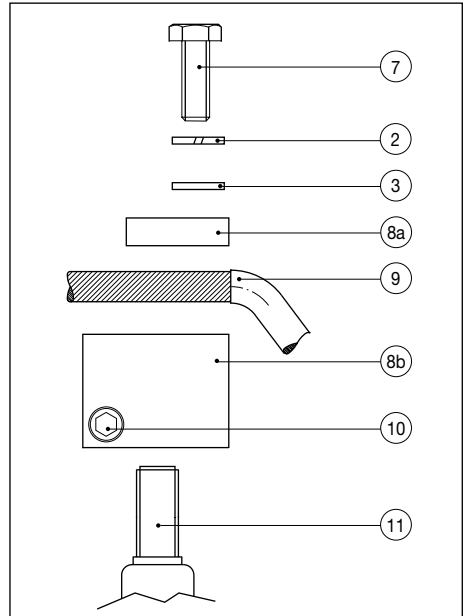

Figure 3 - Connection sequence 280÷315
(Cast iron frame)

Figure 1, 2, 3 - Legend:

- 1 - Nut
- 2 - Spring washer
- 3 - Flat washer
- 4 - Insulated cable lug.
- 5 - Connecting plate
- 6 - Pin
- 7 - Locking screw
- 8a/8b - Cable fastener terminal
- 9 - Power cable
- 10 - Hexagon-head screw for locking terminal
- 11 - Through pin

Connections to the main terminals must be executed using the tightening torques indicated below:

Screw size	Tightening torque maximum [Nm]
M4	2
M5	3,2
M6	5
M8	10
M10	16
M12	25
M16	50

Motors frame size 280-315 and 355 :

the maximum tightening torque on “Locking screw” M8 (particular n° 7 of figure 3) is 20 Nm.

Power Conductors Section [mm ²]		
Terminal	standard	maximum*
M5	6	16
M6	16	35
M10	35	70
M12	70	120
M16	70	150-185-240 (**)

(*) with special cable lugs

(**):

- 150 mm² for version with 6 conductors
- 185 mm² for Ex de / Ex tb version with 3 conductors
- 240 mm² for Ex db / Ex tb version with 3 conductors

The air insulation distances indicated in the following table must be maintained when connections are made among conductors having different potential:

Rated voltage - U [V]	Minimum distance in air - LM [mm]
200 < U ≤ 250	5
250 < U ≤ 320	6
320 < U ≤ 400	6
400 < U ≤ 500	8
500 < U ≤ 630	10
630 < U ≤ 800	12
800 < U ≤ 1000	14

3.2 Auxiliary connections

3.2.1 Thermal protection

With PTC or PT 100 thermistors used for controlling temperature class, the user, in compliance with the essential safety requirements, must alternatively use:

- a device in compliance with IEC61508 standard
- a device that automatically switches to safety position in case of a failure (fail-safe)
- a dual protection circuit.

3.2.2 Anti-condensation heater

The anticondensation heaters must be fed from a different line from the motor power supply one. Check that the power voltage matches the one indicated on the nameplate. The heaters must not operate when the motor is powered.

Check the type of auxiliary present on the motor by looking at the “auxiliaries marking diagram”.

3.3 Cable entries

3.3.1 Introduction

On the terminal box are indicated the cable entrances dimensions; during the installation must be respected the indications of the thread type.

When the cable entry is made using a cable gland, the type of cable gland must be selected correctly in relation to the type of plant and the type of cable. The cable gland must be tightened fully until the seal rings ensure the necessary pressure:

- to prevent transmission of mechanical stress to the motor terminals
- to ensure the mechanical protection (IP degree) of the terminal box.

For Ex db terminal boxes cable entry shall be made with Ex db device certified according to the EN 60079-0 and EN 60079-1 Standards.

Furthermore, they must have a minimum IP55 protection class (IP65 for mines and dust motors). Ex e cable glands certified according to the EN 60079-0, EN 60079-7 must be used for the Ex de eb terminal boxes. Furthermore, they must have a minimum IP55 protection class (IP65 for mines and dust motors).

The seal bushing and cable must be selected on the basis of the maximum operating temperature required for the cable, and indicated on the warning plate if over 70 °C.

Gaskets must not be added, unless supplied by the manufacturer.

Unused cable entries must be closed with certified plugs.

3.3.2 Mines Motors

Motor connections must be realized using cable glands certified for Group I.

The cable entry must be made without modifying the specific properties of the protection type as indicated in the following standards:

- EN 60079-1 for Ex db motors (flameproof protection);
- EN 60079-7 for Ex de eb motors (increased safety protection).
- EN 60079-31 for Ex tb motors (dustproof);
- Mechanical protection IP65.

3.3.3 Gas Motors

Connections must be made in according with EN 60079-14 standard (cable glands or conduit).

The cable entry must be made without modifying the specific properties of the protection type as indicated in the following standards:

- EN 60079-1 for Ex db motors (flameproof protection);
- EN 60079-7 for Ex de eb motors (increased safety protection).

3.3.4 Dust Motors

Connections must be made in according with EN 60079-14 standard (cable glands or conduit).

The cable entry must be made without modifying the specific properties of the protection type as well as the prescriptions given by the following standards:

- EN 60079-31 for Ex tb motors (protective enclosure against dust penetration).

3.4 Earthing connection

Flameproof motors are provided with two earthing terminals: one inside the terminal box and the other on the motor frame. Depending on the cross-section of the line conductor, the earthing conductor cross-section must be:

Line Conductor Section	Earth Conductor Section
$\geq 16 \text{ mm}^2$	$H = S$
from 16 mm^2 to 35 mm^2	16 mm^2
$S \geq 35 \text{ mm}^2$	$H \geq 0,5 S$

3.5 Further warnings for the installation

Flameproof motors must be protected against overloads with automatic power supply disconnection by using a countdown protection device or by using a device to control directly the temperature by means of temperature sensors inserted in the windings.

It is necessary to ensure that the motor ventilation is not impaired by obstacles positioned in the surrounding area when flameproof motors are installed. For this purpose a minimum distance must be maintained between the motor and any device that is not part of the motor, according to the following table:

Size	Minimum distance from other devices [mm]
up to 160	40
from 180 to 225	85
≥ 250	125

The terminal board box must always be closed before starting the motor.

After having restored the original layer of grease (for example Molyduval, Bariplex, Avio type), refit the terminal box lid and tighten the fastening screws.

Tightening torques [Nm]						
Aluminium frame						
Steel class	M4	M5	M6	M8		
8.8 (A4-80)	2	3.2	5	12		
12.9	3	4.8	7.5	18		
Cast iron frame						
Steel class	M4	M5	M6	M8	M10	M12
8.8 (A4-80)	2.9	5.6	10	23	35	80

3.6 Warnings regarding electrostatic charges

For flameproof motors that have IIC markings, the risk of electrostatic charges must be considered: keep the surfaces of the motor clean using a damp cloth.

3.7 Special operating conditions

The certificate number contains the letter “X” for the following reasons:

- The dimensions of the joints are different from those indicated in the reference standards. Consult chapter 11 if repairs are needed.
- The temperature class is guaranteed in a voltage variation range of +/-5%
- Due to the possible presence of electrostatic charges in IIC enclosures with special paint (thickness exceeding 0.2mm), consult chapter 3.6.

4. Motors without terminal box with cable leading out of plate

When the motor comes without a terminal box, the motor's enclosure is closed with a plate with the power supply cable leading out of it. To install correctly, the user must follow the instructions below.

Note

Mines Motors are made only with cable glands exit (see 4.1).

4.1 Motor with plate, armoured cable and cable gland

An armoured cable leads out of the motor plate clamped by an appropriate cable gland.

The user must protect power supply cables from possible damage arising from mechanical stress, and must connect ends of cables according to one of the safety methods provided for by standard EN 60079-0, in conformity with engineering rules in force for the place where the motor is to be used.

4.2 Motor with plate and “conduit”

In this case motor enclosure is sealed through a locking joint fixed on the motor plate.

From the locking joint departs a “conduit” (its length has defined in the order phase) that finishes with another locking joint. Inside such conduit pass the wires to energize the motor.

User has to provide that wire end to terminals placed into a proper terminal box. Should the terminal box been located in classified area, it must be chosen according to one of the methods of protection foreseen by the norm EN 60070-0.

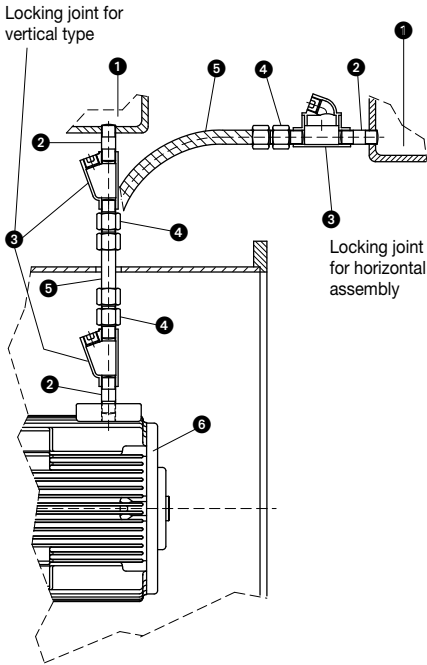

Fig. 4 - Cable exit with "Conduit" for Gas and Dust

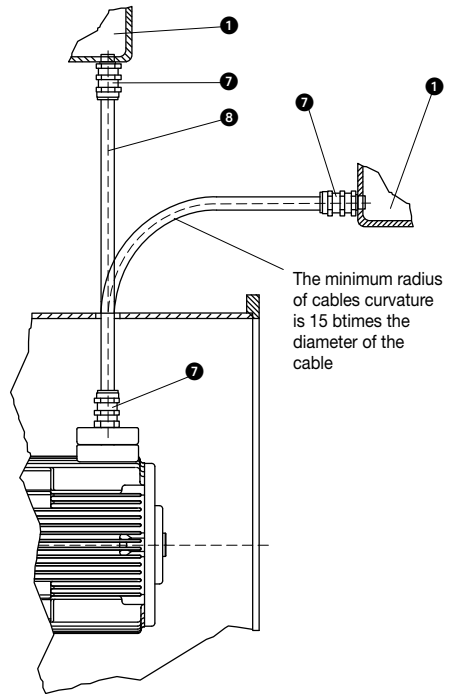

Fig. 6 - Cable exit with cable glands for Gas and Dust

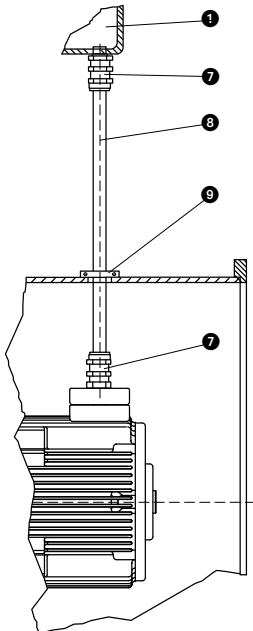

Fig. 5 - Cable exit for motors mine, maximum length cable 2m

Legend Fig. 4, 5 and 6

- 1 Terminal box
- 2 Nipple
- 3 Locking joint (vertical and/or horizontal)
- 4 Fitting in three pieces
- 5 Flexible pipe (conduit)
- 6 Motor
- 7 Cable gland
- 8 Armoured cable
- 9 Clamping device for cable

5. Motors without fan

5.1 Cooling method IC 418

In this variant, ventilation is provided by a fan directly coupled to the motor.

Ensure that the motor ventilation is present in all operating conditions and that the temperature limits allowed by the insulation category B are complied with.

Fans must respect the norms of product related to the ventilators and they have to guarantee the cooling of the motor. The fan, at least, has to respect the distance of 5 mm from the fixed parts of the motor.

In zones 21 or 22, it is necessary to observe the prescriptions of the norms EN 60079-31.

5.2 Cooling method IC 410

In this variant motor has no cooling fan and it is necessary respect the following recommendations:

- For "S1" operation, the motor power output is derated by 50% to comply with the limits allowed by insulation class B.
- For "S2" operation, nominal out put power is accepted providing that motor does not work so long to exceed the temperature limits of insulation class B. Said time limit is indicated on the nameplate.

6. Motors with forced ventilation

6.1 Cooling method IC 416

Cooling is assured by ventilation provided by an auxiliary flameproof motor, covered by separate certification, fitted on the back of the main motor.

The user must fit a safety device enabling the main motor to be started only once the auxiliary motor is running.

In addition, motors must be equipped with PTC or PT100 thermal probes, which must be connected with a tripping relay disconnecting the motor's power supply. This relay must have automatic reset.

7. Motors for low temperatures

Motors designed to be used at low ambient temperatures have construction characteristics that make them ideal for use at temperatures between -20 °C and -50 °C.

The minimum and maximum temperatures are indicated on the nameplate.

To use these motors correctly, special attention must be given to the following point:

- Any auxiliary devices used, such as preheating coils, must be powered when the motor is not running.
- Screws and bolts are in A4-80 STAINLESS STEEL and if, replaced, they must be replaced with others of the same quality.
- The fan guards are made of steel and the cooling fans of aluminium. If replaced, these must be done with spare with the same qualities.
- The terminal boards / passing terminals are especially certified for these temperatures, and must be replaced with original components.
- The grease used to protect the joints must be suitable for the temperature fluctuation ranges experienced in the plant (e.g. "Aereo 92" type).
- The cables used to energize the motors and the cable glands on the terminal board box must be suitable for the ambient temperatures.
- The insulation materials in particular must be suitable for the temperature fluctuation ranges the motors are subject to, both as a result of seasonal changes in the ambient temperature, and temperature increases due to motor running while loaded.

8. Motors suitable for frequency converter drive

For operation with an inverter, motors must be equipped with PTC or PT100 sensors inserted in the winding to ensure compliance with the limits of the temperature class.

The user must connect the PTC or PT100 terminals to a tripping relay ensuring that the power supply is cut off whenever a dangerous temperature is reached.

The reset of this cut-out must be performed manually only, and not automatically.

The user, in compliance with the norms, must:

- use a tripping relay out in compliance with EN 61508 standard (Fail Safe type)
- use a dual protection circuit.

When temperature class is T5 or T6 the condition for use is indicated on the certificate.

Inverter motors have an auxiliary plate. Before starting the motor, check the ratings (kW - Hz - torque) indicated on the auxiliary plate. The user must contact the manufacturer if this information is not provided.

When the motor comes with forced ventilation provided by an auxiliary motor, the user must follow instructions given in point 6.1 (Cooling method IC416).

Rated performance relating to operation at mains power frequency cannot be maintained if powered by an inverter. In particular, power output could be significantly reduced to maintain the assigned temperature class and to avoid damage caused by overheating.

The choice of the type of frequency converter must be made taking into account that the motor must not be subjected to voltage peaks exceeding 1.4 times the nominal voltage, which would significantly reduce the life of the windings insulation. It is necessary to consider in this respect that the voltage peaks value is also influenced by the length of the supply cable. Induction motors supplied from the mains conform to the immunity and emission limits relating to electromagnetic compatibility as foreseen by the standards.

When power is supplied by a frequency converter, the installer bears responsibility for checks and any measures required to comply with immunity and emission limits as laid down by the standards.

9. Motors with brake

9.1 General remarks

In addition to the provisions for normal motors, motors with brake require special measures to guarantee correct operation.

Motors with brake are normally provided for horizontal operation. If positioned vertically the brake could be subject to operational malfunctions. Observe the installation conditions provided upon ordering.

9.2 Brake power supply

Connections to be made by qualified personnel following the prescriptions of chapters 2 and 3.

When setting up the connection, reference must be made to the diagram provided with the motor, bearing in mind that the brake can be provided with different types of power supply:

- Three-phase power supply (same or different voltage of the motor)
- Single-phase power supply (always different to the one of the motor)
- Direct current power supply (always different to the one of the motor)

Before setting up the connection, check the information provided on the nameplate.

NB:

- In the event that the motor is powered by inverter, the brake must have its own power supply separate to that of the motor.
- The brake is provided already calibrated with the braking torque requested upon ordering. No adjustments or checks of the brake itself are required before commissioning.
- For disassembly and assembly refer to the relevant use and maintenance manual.

10. Inspections and maintenance of motors

The inspections and maintenance of motors Category 2G, 2D shall be executed in compliance with the criteria of the EN 60079-17 standards.

The electrical connection terminals must be tightened fully to avoid high contact resistances and consequential overheating.

Care must be taken to ensure that the insulation distances in air and on the surfaces between the conductors are maintained, as established by the standards.

All bolts used to secure both motor and terminal box must be tightened using the torque values as indicated in the table TIGHTENING TORQUES par. 3.5. All screws utilised to seal the motor and the terminal board shall be tightened fully.

Replacement of gaskets and cable entry parts shall be executed using components that are identical to the components supplied by the manufacturer to ensure the protection degree is maintained.

The surfaces of flameproof joints must not be machined and sealing gaskets different from those supplied by the manufacturer must not be inserted. These surfaces must be maintained in a clean condition.

A thin layer of non-hardening grease must be used against corrosion and to prevent water from entering. This grease layer must be renewed at every disassembly.

11. Repairs of for classified areas motors

Repairs made to flameproof motors Ex db/de eb or Ex tb shall be executed in compliance with the criteria specified by EN 60079-19 standard, by the certifications and by this manual.

Joints dimensions evaluation involves the producer, when it is necessary address to him (see Fig. 7).

If repairs are not executed by the manufacturer, they must be carried out at workshops which have the necessary equipment and with adequate technical expertise concerning the motor protection methods and must be supervised by qualified and authorized personnel.

If repair work involves parts that influence the protection against explosions, the motor construction data must not be changed (for example: dimensions of joints, winding characteristics, etc.) and if parts have to be replaced, this must be done with original components.

Norm EN 60079-19 foresees various typologies of intervention that have different impacts on the integrity of the equipment submitted to maintenance; the possible activities are synthesized below.

- 1 - Repair:** Action to restore a faulty apparatus to its fully serviceable condition and in compliance with the relevant standard (relevant standard means the standard to which the apparatus was originally designed).
- 2 - Overhaul:** Action to restore to a fully serviceable condition an apparatus which has been in use or in Storage for a period of time but which is not faulty
- 3 - Maintenance:** Routine actions taken to preserve the fully serviceable condition of the installed apparatus.
- 4 - Reclamation:** Means of repair involving, for example, the removal or addition of material to reclaim component parts which have sustained damage, in order to restore such parts to a serviceable condition in accordance with the relevant standard.
- 5 - Modification:** Change to the design of the apparatus which affects material, fit, form or function.

Producer supports the activities of:

- 1** - Reparation
- 2** - Overhaul
- 3** - Maintenance
but doesn't authorize interventions of:
- 4** - Reclamation
- 5** - Modification.

Possible constructive modifications can be performed, in the respect of the ties of the certificate, only by the manufacturer.

When it is necessary to verify the flameproof joints, the scheme furnished in Figure 7 must be applied.

It is not always necessary to make the control of the flameproof joints (for instance when doing an activity type 2-Overhaul on a new motor withdraw from stock).

A written report must be prepared by repairer with the detailed indication of the work carried out.

After the repair work has been properly completed, an additional nameplate shall be affixed to the motor (without removing the original one) showing the following marks:

- symbol **R**
- name or trademark of the repairer
- reparation number by the repairer
- date of repair

In case the reparation modify relevant aspects concerning protection against explosions and motor does not comply with the certificate, the original nameplate must be removed and the motor can no longer be used in areas where there is danger of explosion.

Unless of re-examination and approval by a competent certification body.

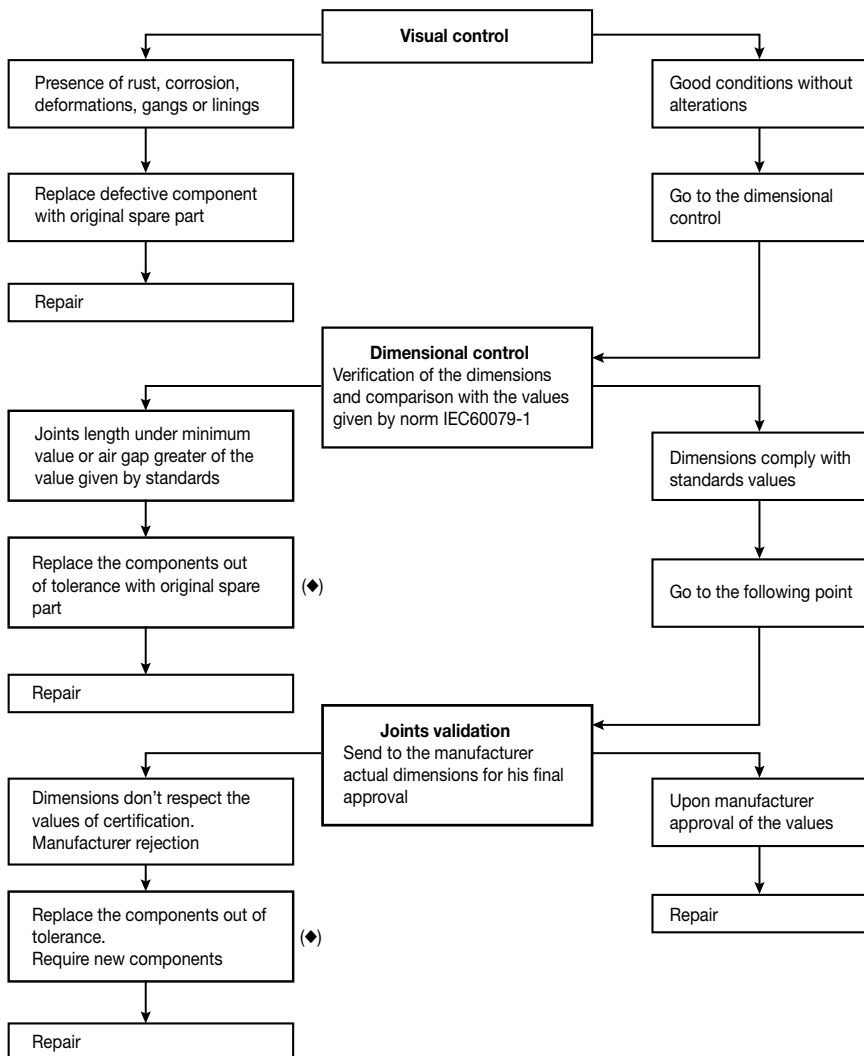

(◆) In alternative repair the motor and de-rate it as for use in safe areas

Fig. 7 - Check list for flameproof joints

Nel redigere questa documentazione è stata posta ogni cura al fine di assicurare la correttezza delle informazioni contenute.

Tuttavia, anche in conseguenza della politica di continuo sviluppo e miglioramento della qualità del prodotto perseguita da **Cemp**, la società si riserva il diritto e la facoltà di apportare modifiche di qualsiasi genere, in qualsiasi momento e senza preavviso, sia a questo documento sia ai propri prodotti.

Le descrizioni e le caratteristiche tecniche della presente pubblicazione non sono quindi impegnative e i dati riportati non costituiscono, in nessun caso, impegno contrattuale.

Every care has been taken to ensure the accuracy of the information contained in this publication.

Due to **Cemp's** policy of continuous development and improvement, the company reserves the right to supply products which may differ slightly from those illustrated and described in this publication.

Descriptions and technical features listed in this brochure may not be considered as binding. Under no circumstances should data in this publication be considered as a contractual obligation.

Dans la préparation de cette documentation nous avons pris le soin d'y intégrer les informations les plus exactes possibles.

Néanmoins, compte tenu de notre politique de développement et d'amélioration continue des produits, la Société **Cemp** se réserve le droit et la faculté d'apporter toute modification sur la documentation et sur les produits, à tout moment et sans préavis.

Les descriptifs et les caractéristiques techniques contenus dans ce catalogue n'engagent pas la Société. Par conséquent, ces données ne constituent en aucun cas un engagement contractuel.

Die Ausführungen und technischen Eigenschaften, die in dieser Broschüre angegeben sind, dürfen nicht als verbindlich angesehen werden.

In keinem Fall können jedoch die in diesem Dokument aufgeführten technischen Daten als rechtlich verbindlich angesehen werden.

Cemp behält sich das Recht vor, ohne Mitteilung, jegliche Abweichungen und Änderungen jederzeit vorzunehmen, sowohl in diesem Dokument als auch bei den Produkten, die hier beschrieben sind.

La presente documentación se ha redactado de manera muy atenta para poder asegurar que las informaciones que contiene son correctas.

No obstante, como consecuencia de la política de continuo desarrollo y mejora de la calidad del producto que **Cemp** pone en práctica, la sociedad se reserva el derecho y la facultad de modificar en lo que fuera necesario, en cualquier momento y sin que para ello medie preaviso alguno, tanto este documento como sus productos.

Por lo tanto, las descripciones y las características técnicas indicadas en el presente documento no son vinculantes, y los datos que contiene no constituyen en ningún caso, vínculo contractual.



HEADQUARTER
Cemp S.r.l.

Via Piemonte, 16
20030 Senago (Milan) - Italy
Tel: +39 02 94435401
cemp@regalbeloit.com

BRANCH
Germany International GmbH

Dr. Atzinger-Strasse 5
94036 Passau - Germany
Tel: +49 (0) 8519662320

OFFICE

14 Rue de Cours Neuves,
ZA de la Peupleraie
77135 Pontcarré - France
Tel: +33 (0) 164668736

All brands and trademarks are the property of their respective companies
and are protected by copyright law.

A Regal Brand

